

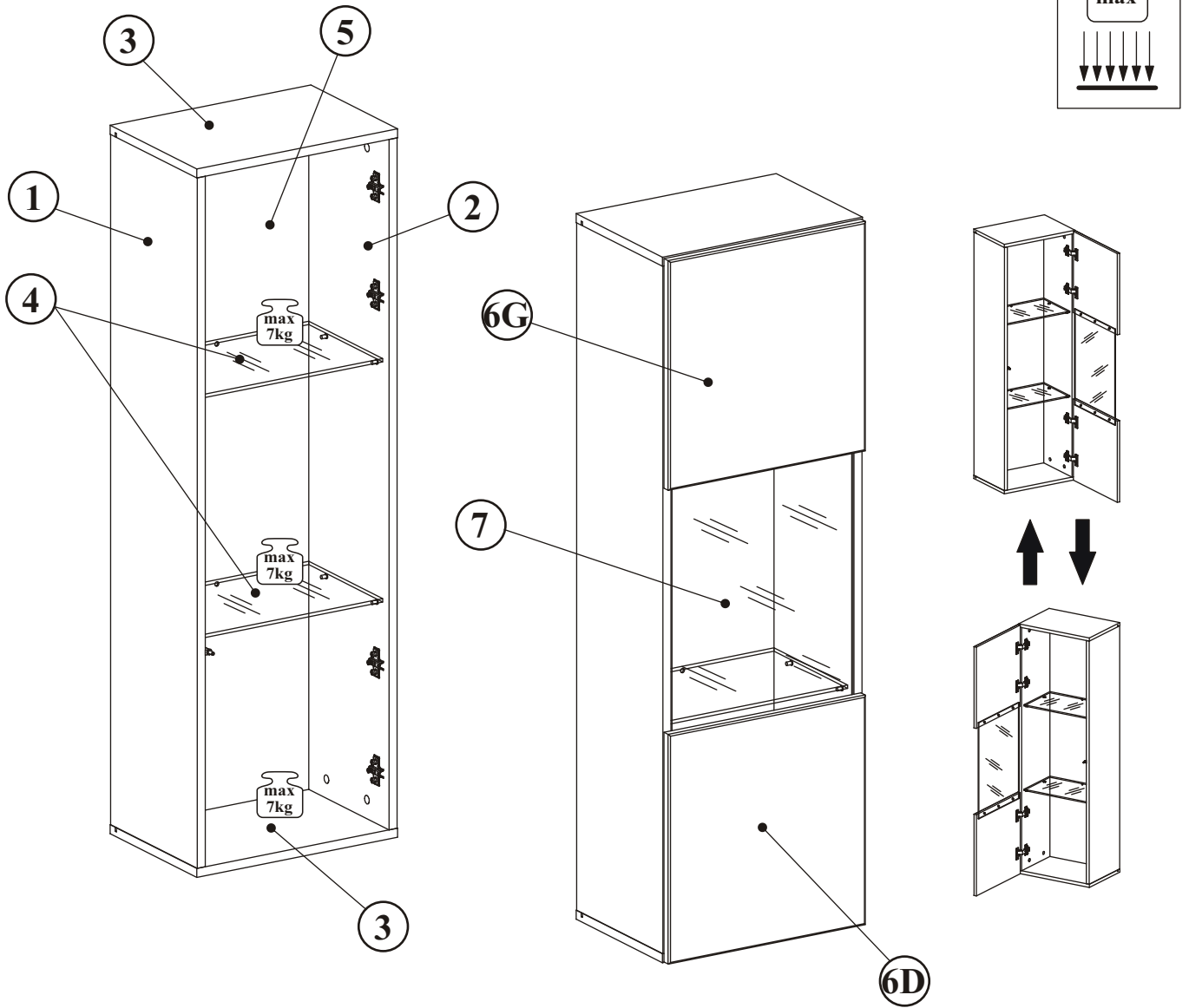

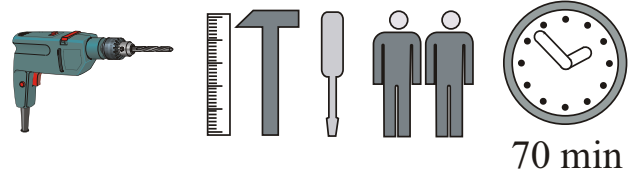





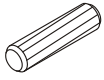
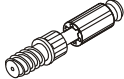
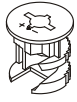

POINT TYP-22

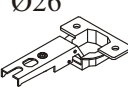
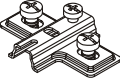
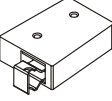
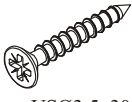
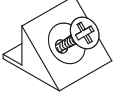

NO	Dim.		Col.-No	Qty
1	1228	274	1	1
2	1228	274	1	1
3	400	274	1	2
4	364	234	1	2
5	1240	378	1	1
6G	394	410	1	1
6D	394	410	1	1
7	485	362	1	1

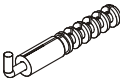
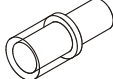

POINT TYP-22

A1 x8  ø8x36	B4 x8 	B5 x8  ø15x12	G5 x8 	E1 x4  Ø26 H=0	E2 x4  H=0
ZR1 x2 	D6 x4  USØ3,5x30	S1 x10 	D10 x10  USØ3,5x13	UP13 x6  UPØ3x16	P2 x6 
KR2 x2 	G20 x8 	G2 x1 	Z2 x8  Ø5	T1 x1 	

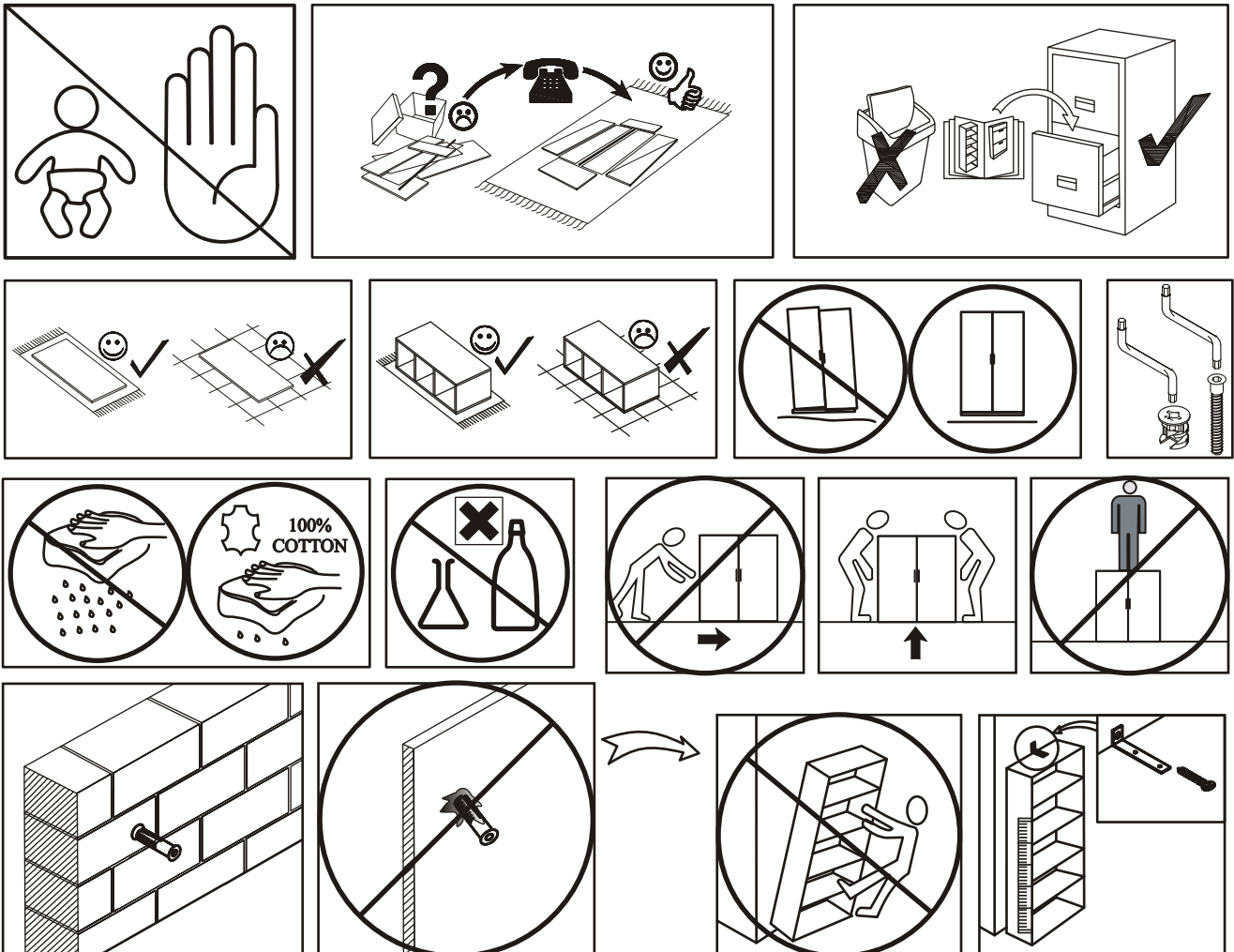
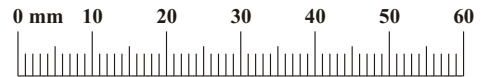

POINT TYP-22

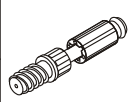
B4	
x8	

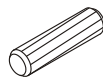
A1	
x8	ø8x36

B5	
x8	ø15x12

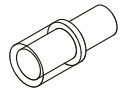
G20	
x8	

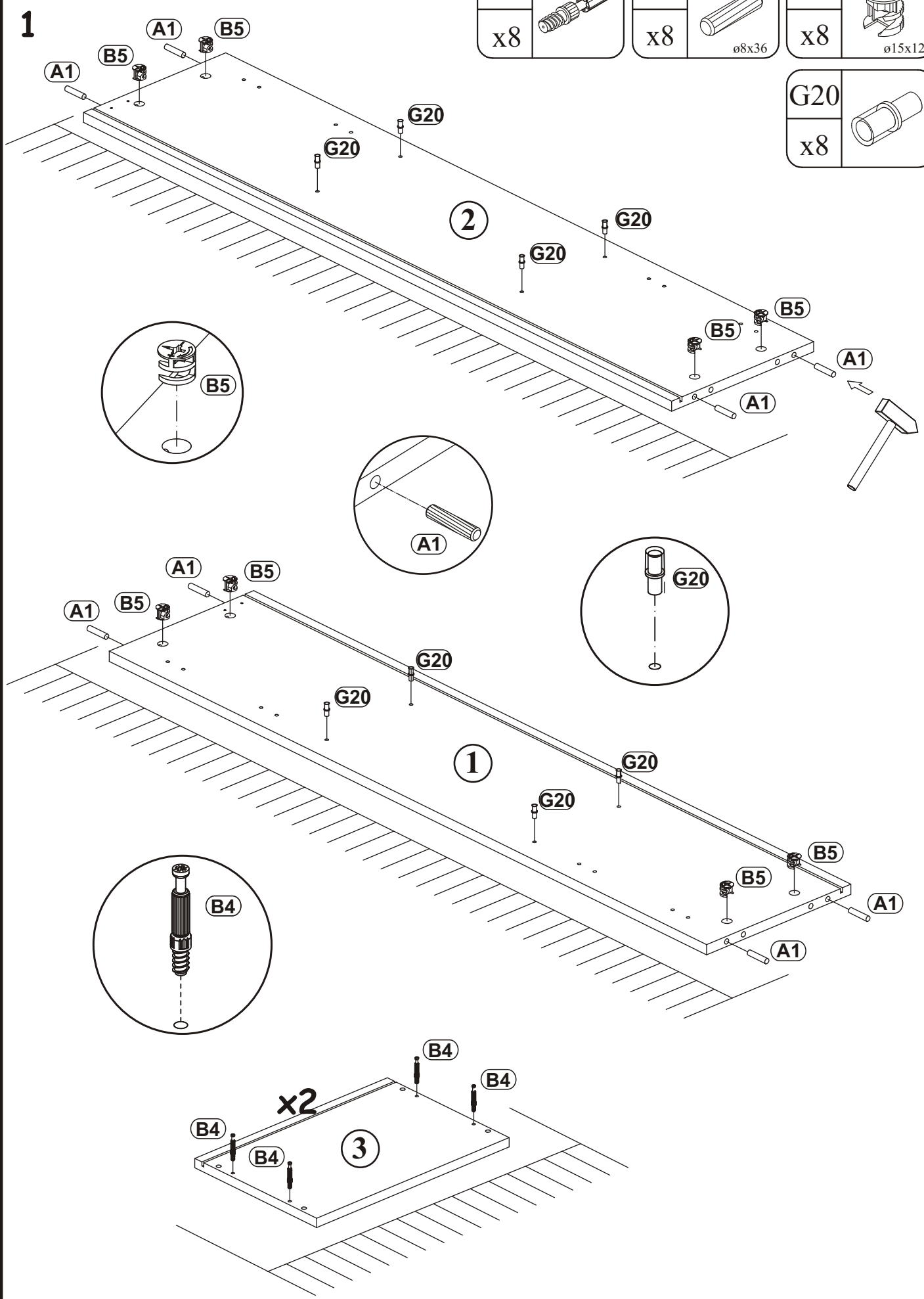

POINT TYP-22

2

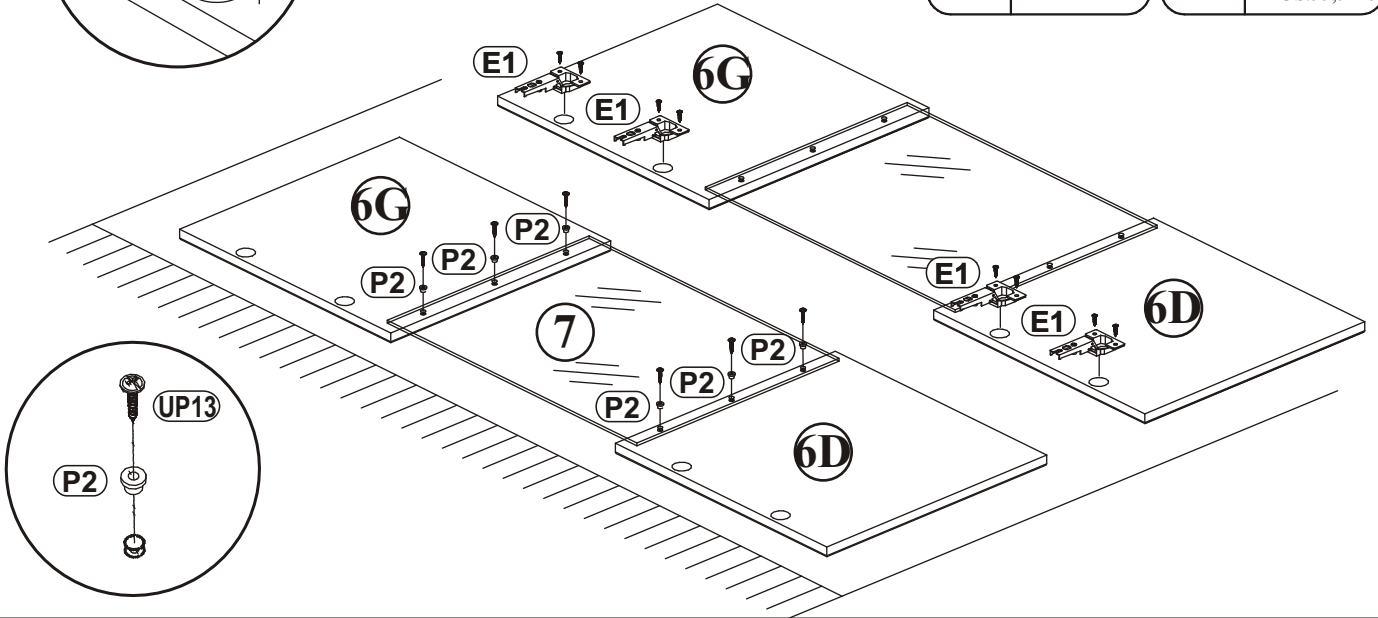
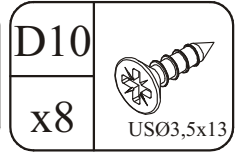
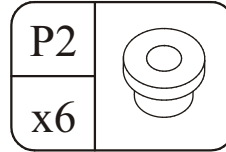
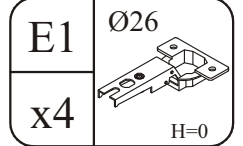
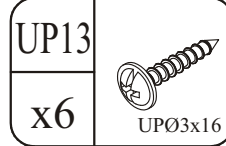
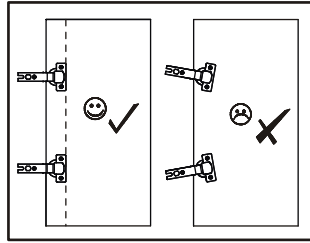
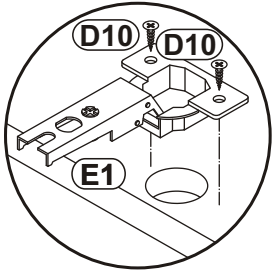

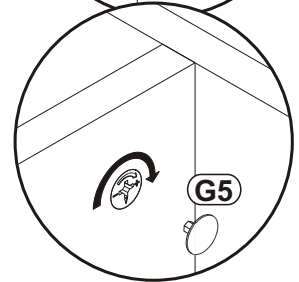
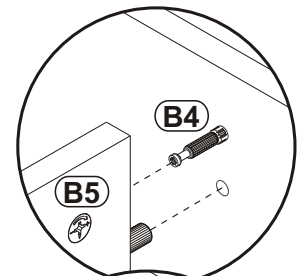
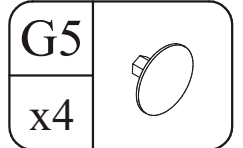
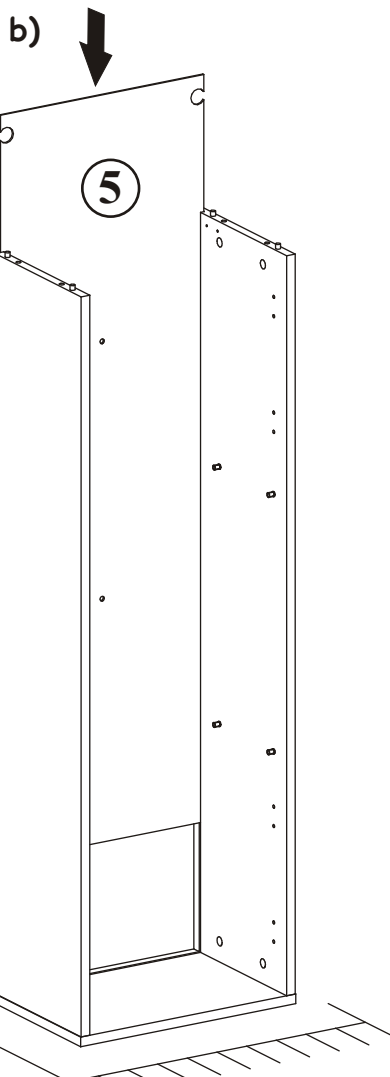
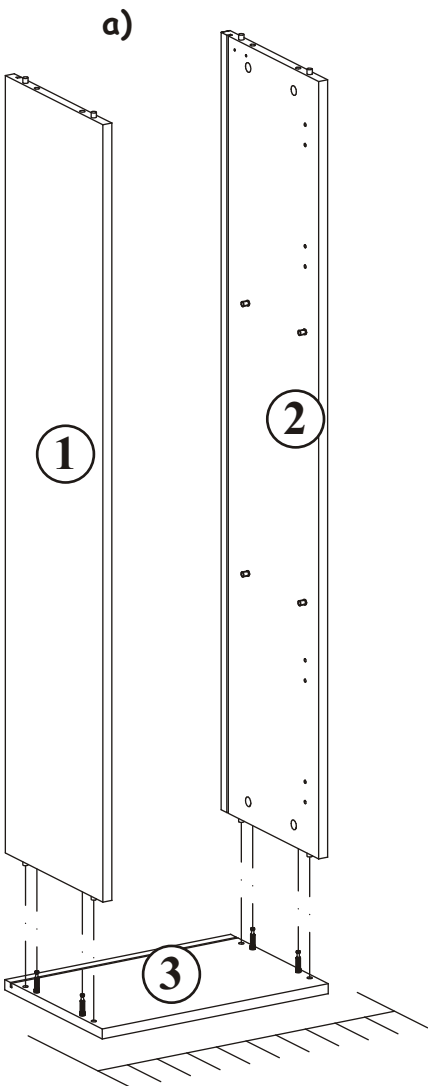

3

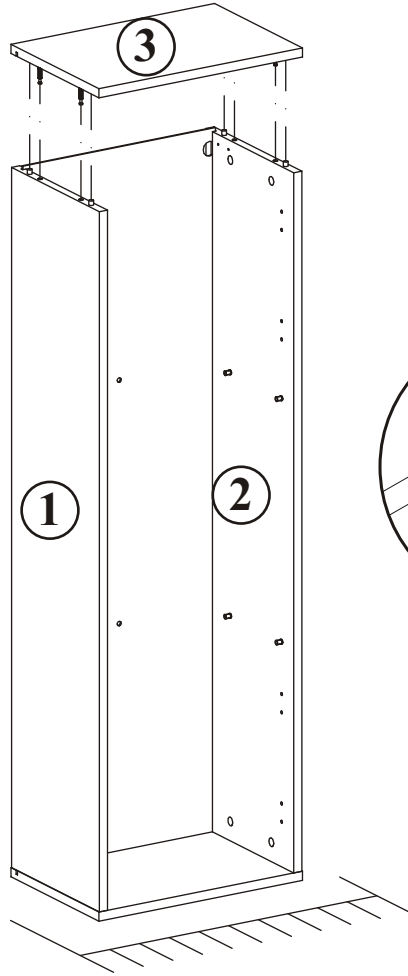

POINT TYP-22

4



G5	
x4	

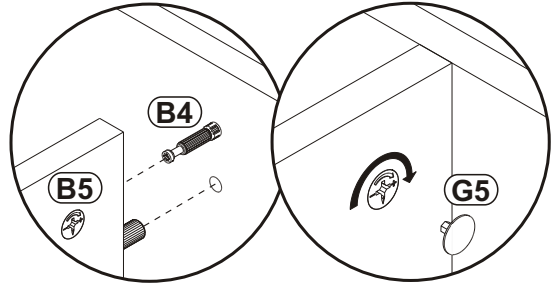

5

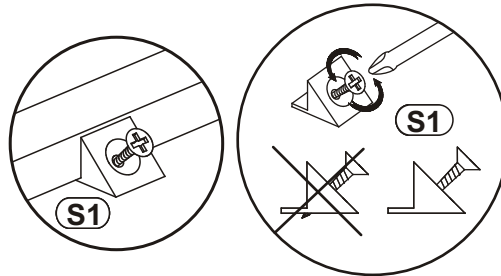

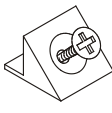
S1	
x10	

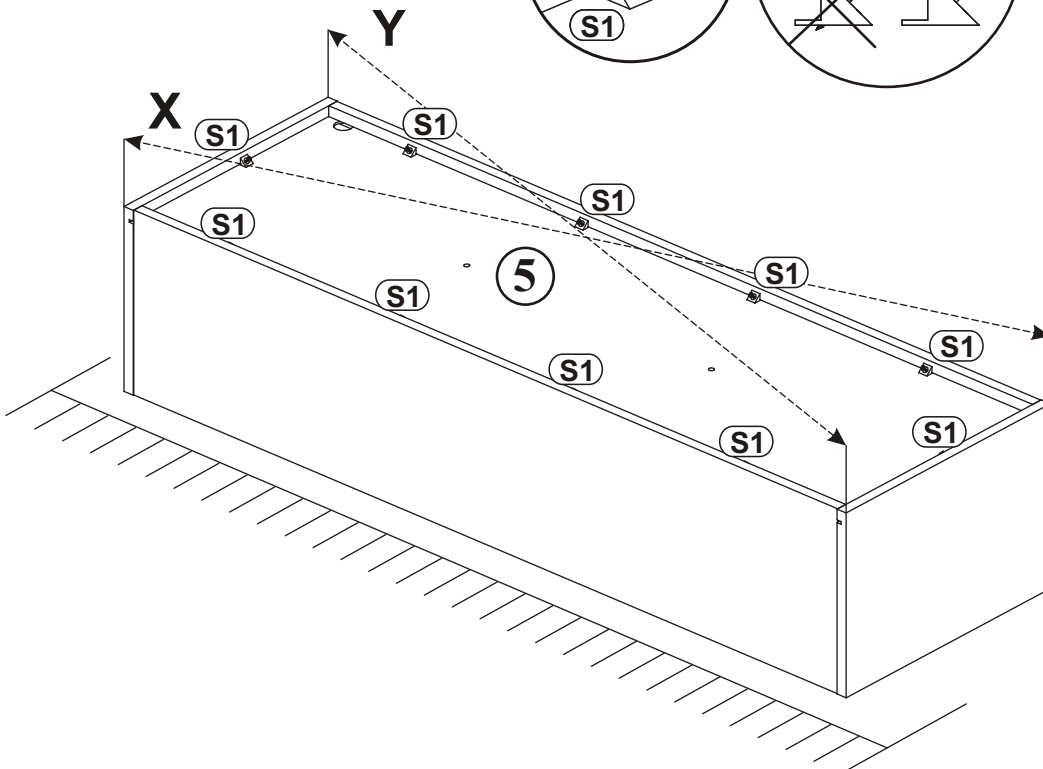

POINT TYP-22

6

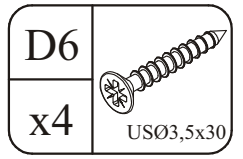
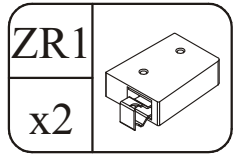
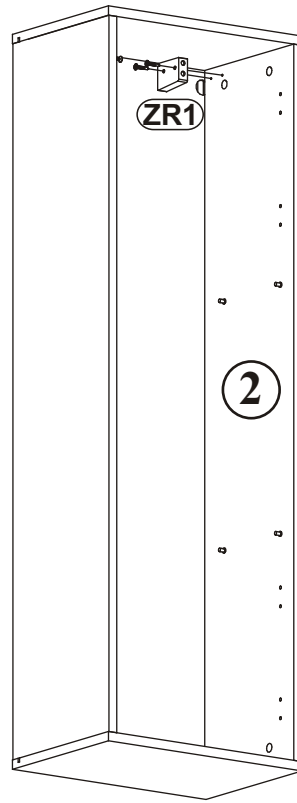
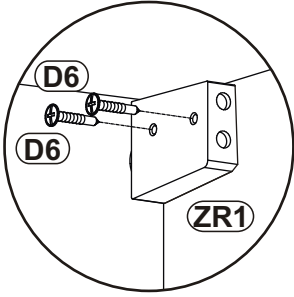
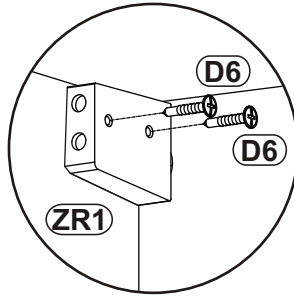
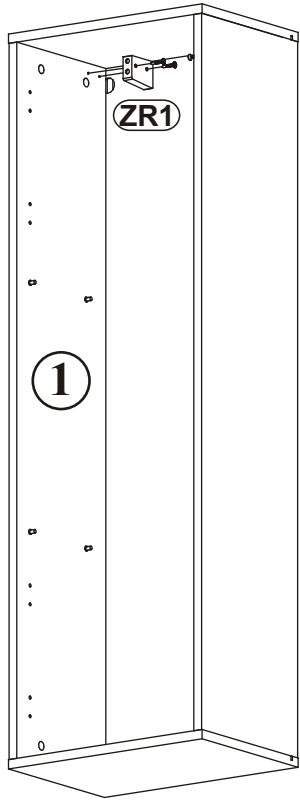

7

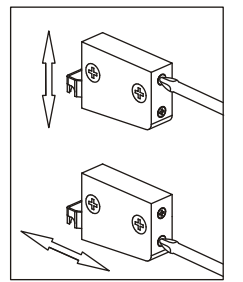
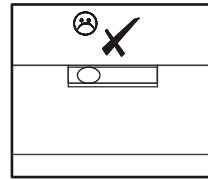
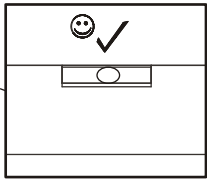
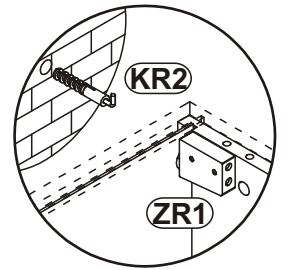
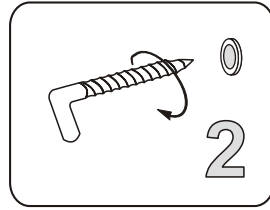
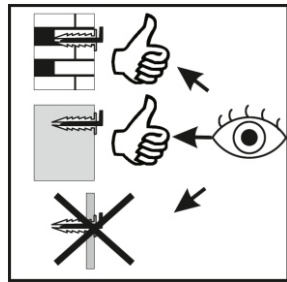
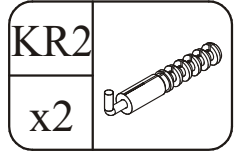
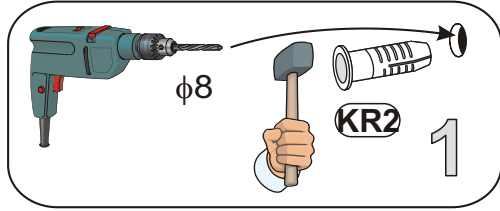
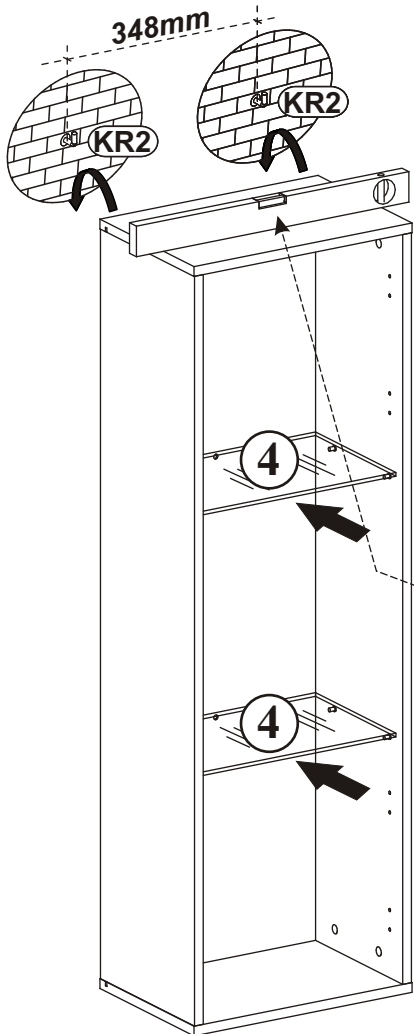

8 - 9

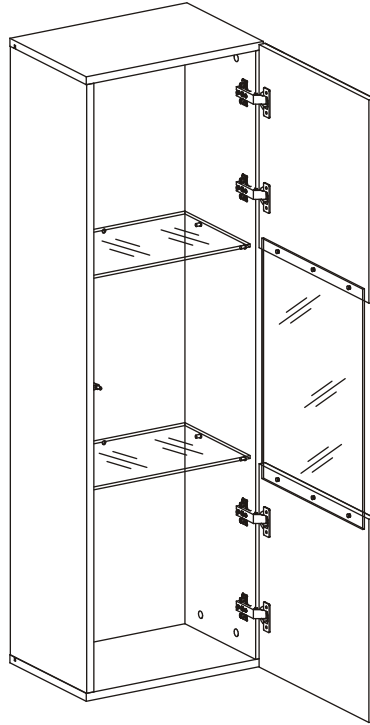

10 - 11

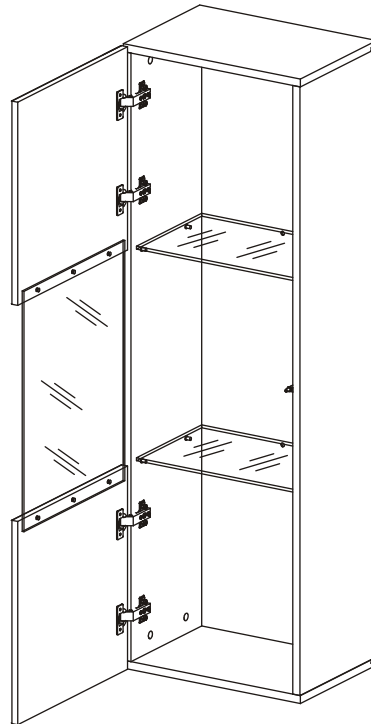

POINT TYP-22

8

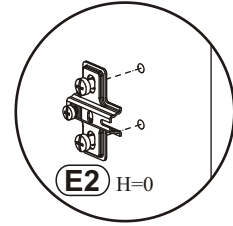
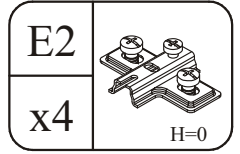
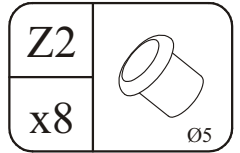
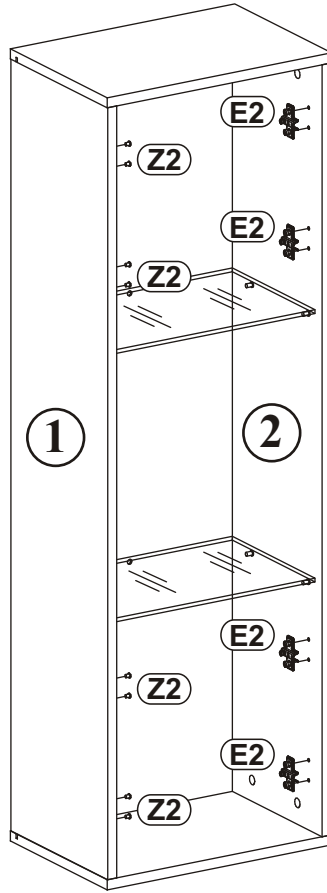
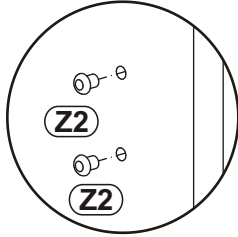
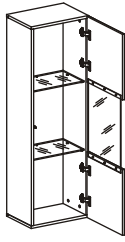

9

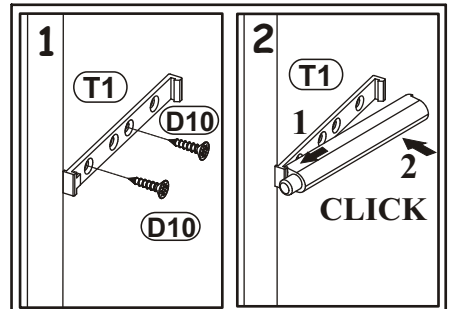
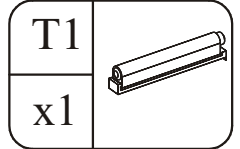
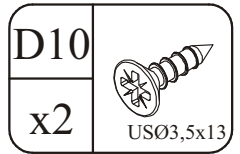
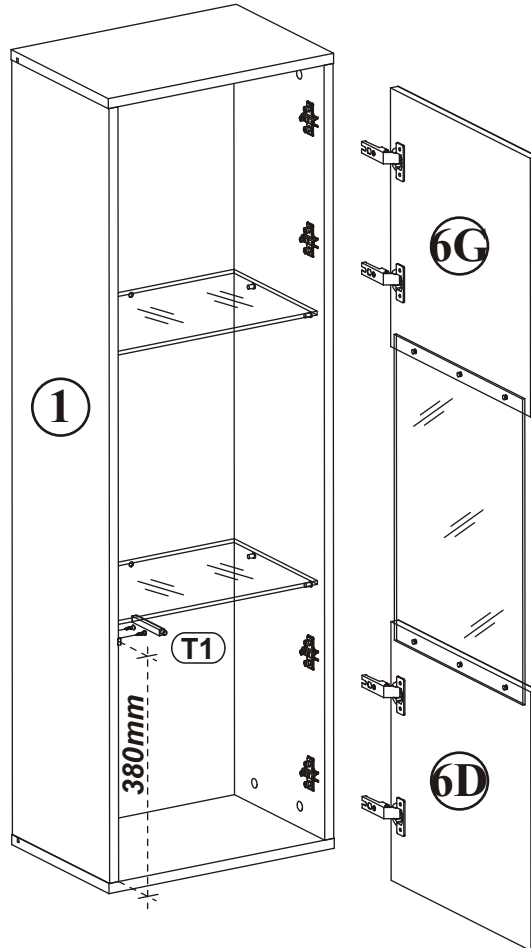
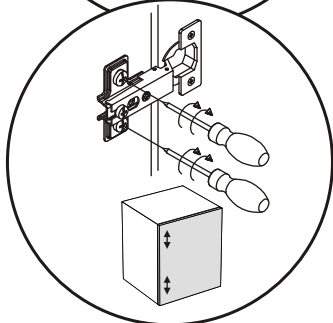
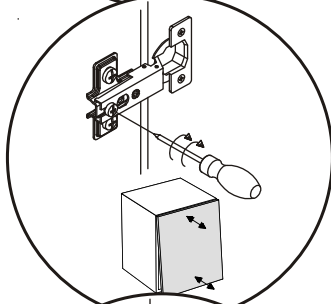
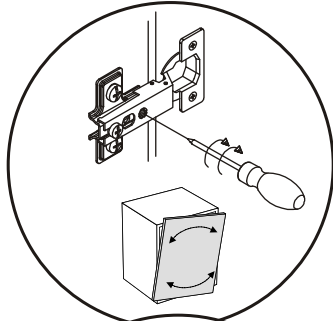

POINT TYP-22

10

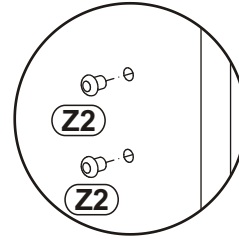
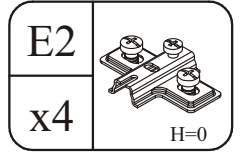
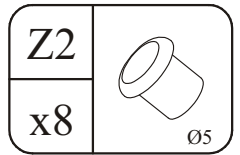
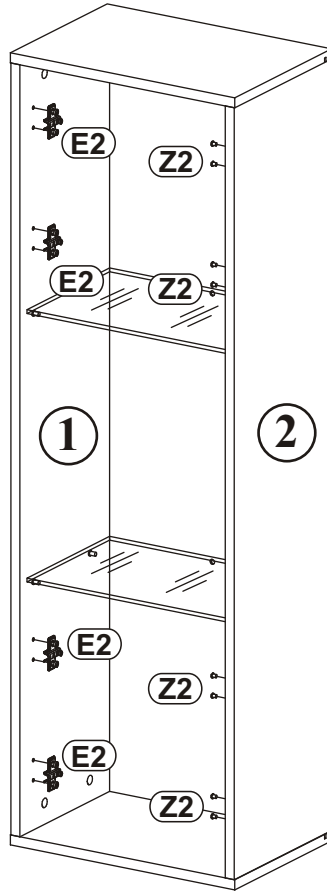
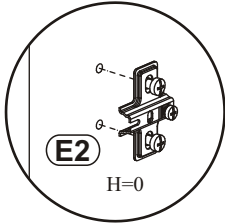
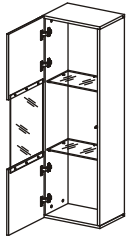

11

