

# POINT TYP-41

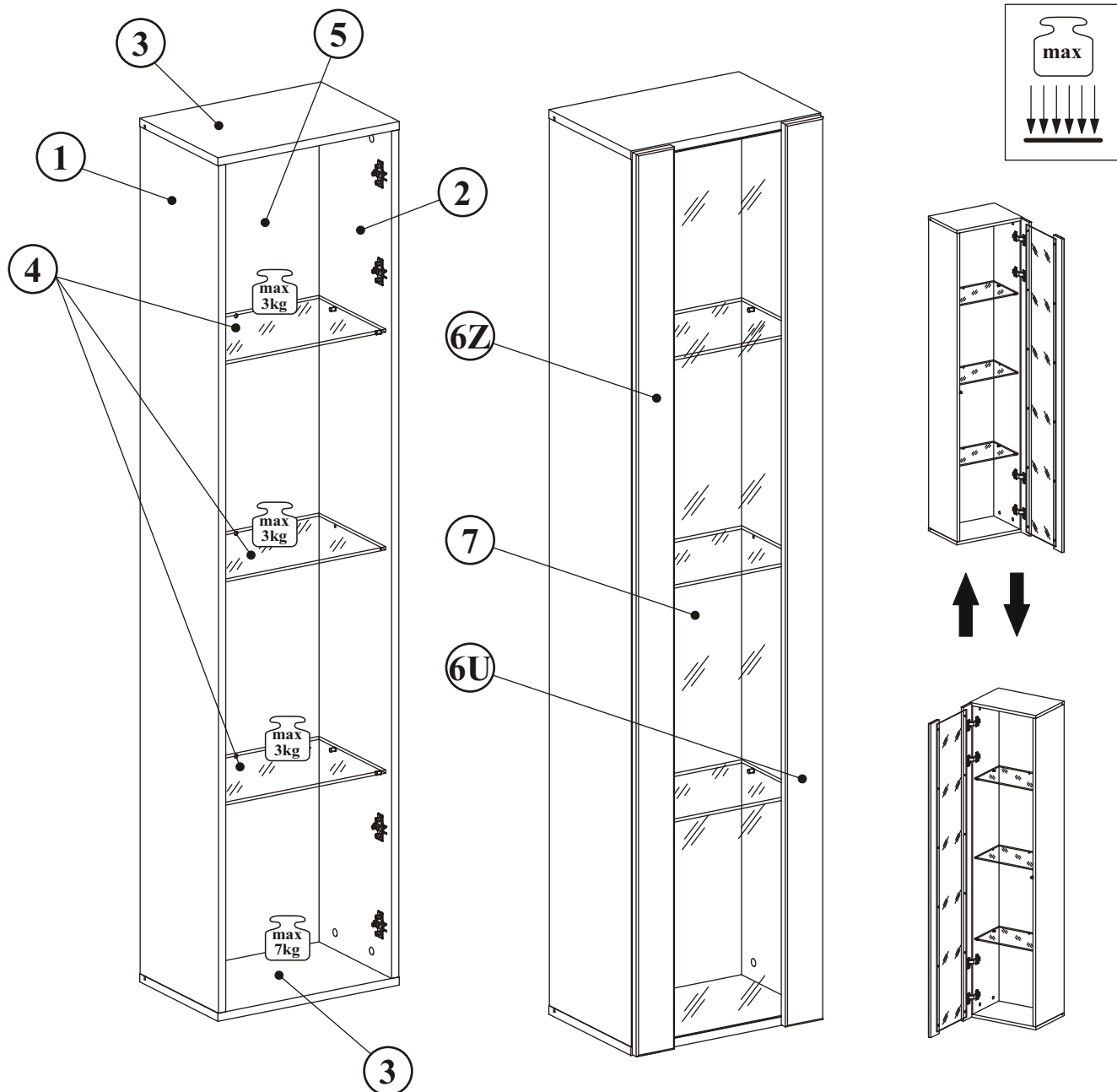

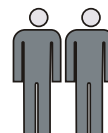

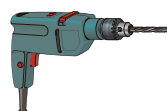





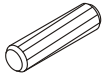
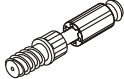
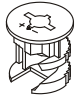

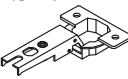
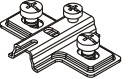
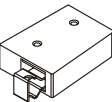

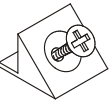
NO	Dim.		Col.-No	Qty
1	1668	274	1	1
2	1668	274	1	1
3	400	274	1	2
4	364	234	1	3
5	1680	378	1	1
6Z	80	1696	1	1
6U	80	1696	1	1
7	1664	283	1	1

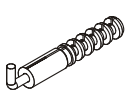
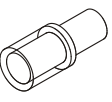

70 min

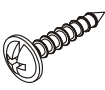
# POINT TYP-41

A1 x8  ø8x36	B4 x8 	B5 x8  ø15x12	G5 x8 	E1 x4  Ø26 H=0	E2 x4  H=0
ZR1 x2 	D6 x4  USØ3,5x30	S1 x12 	D10 x10  USØ3,5x13	KR2 x2 	G20 x12 
Z2 x8  ø5	T1 x1 	G2 x1 	UP13 x12  UPØ3x16	P2 x12 	

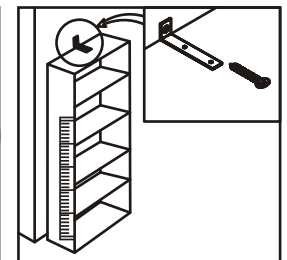
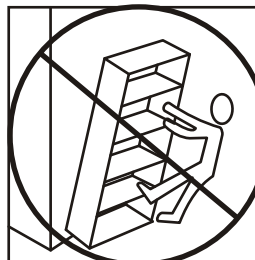
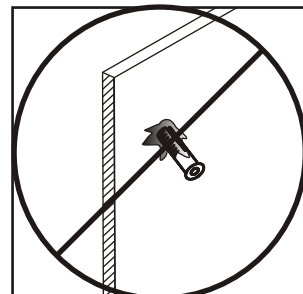
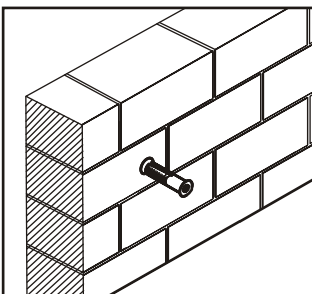
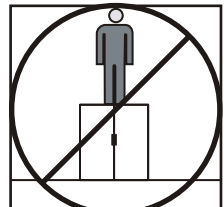
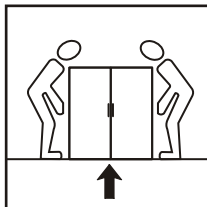
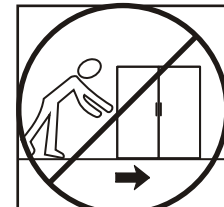
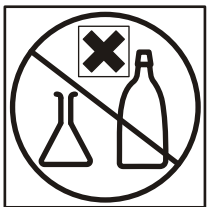
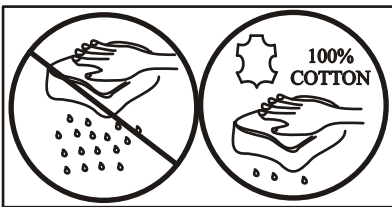
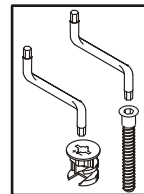
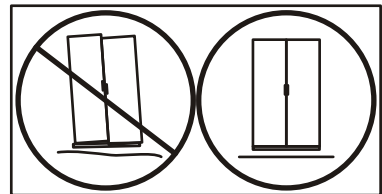
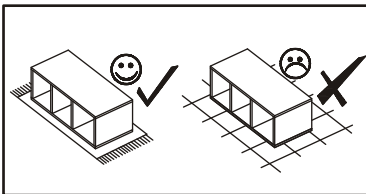
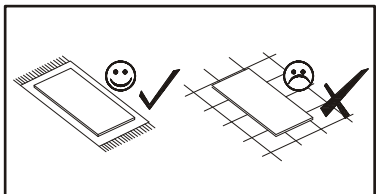
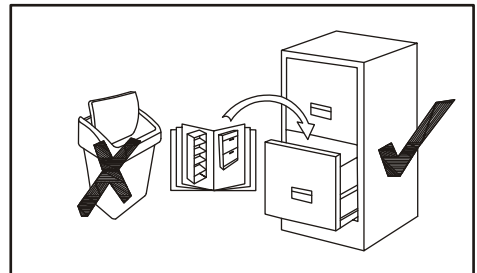
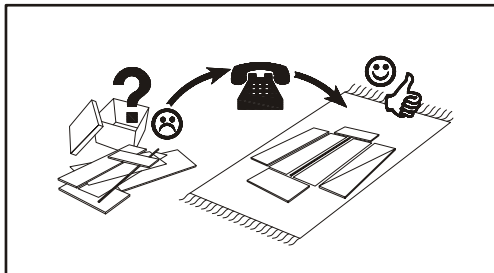
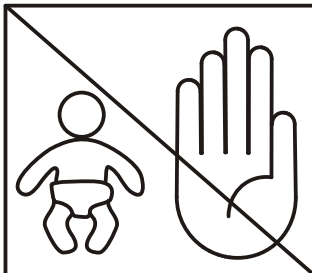
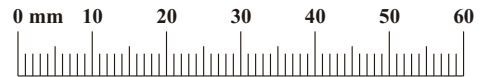

# POINT TYP-41

1

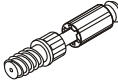
B4	
x8	

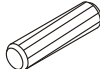
A1	
x8	ø8x36

B5	
x8	ø15x12

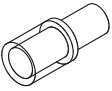
G20	
x12	

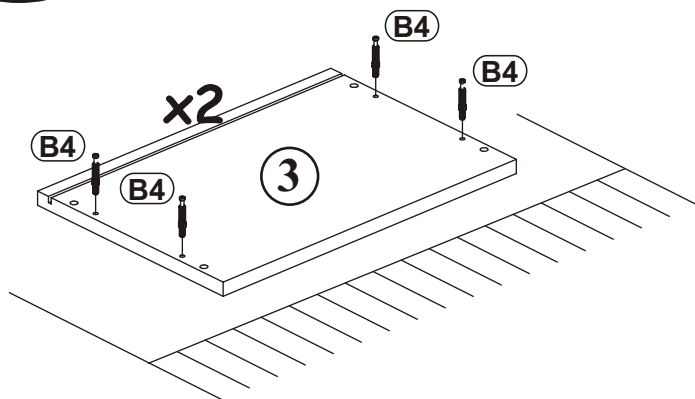
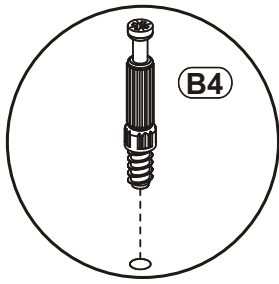
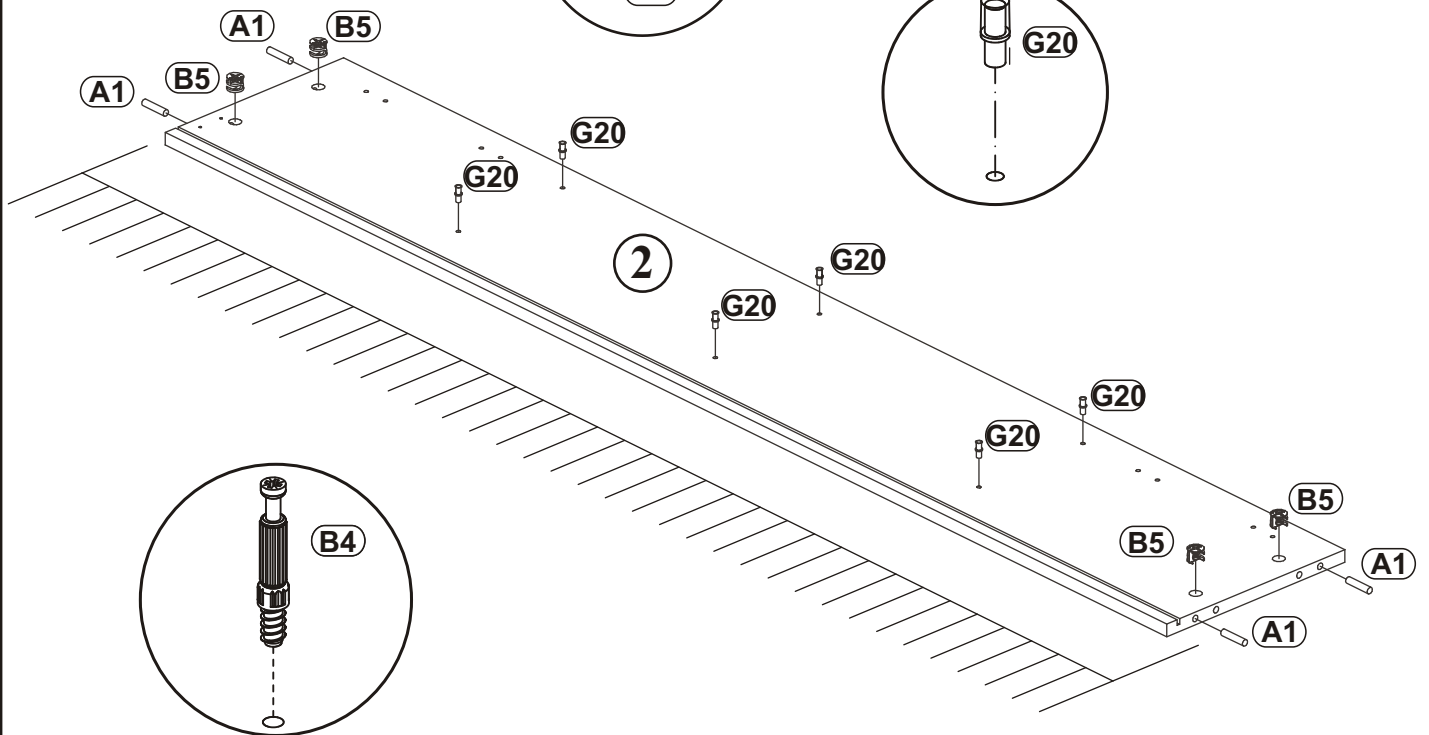
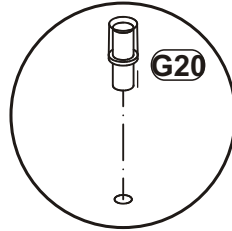
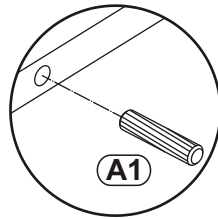
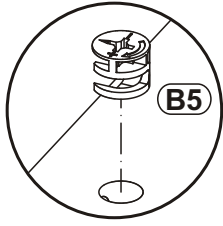
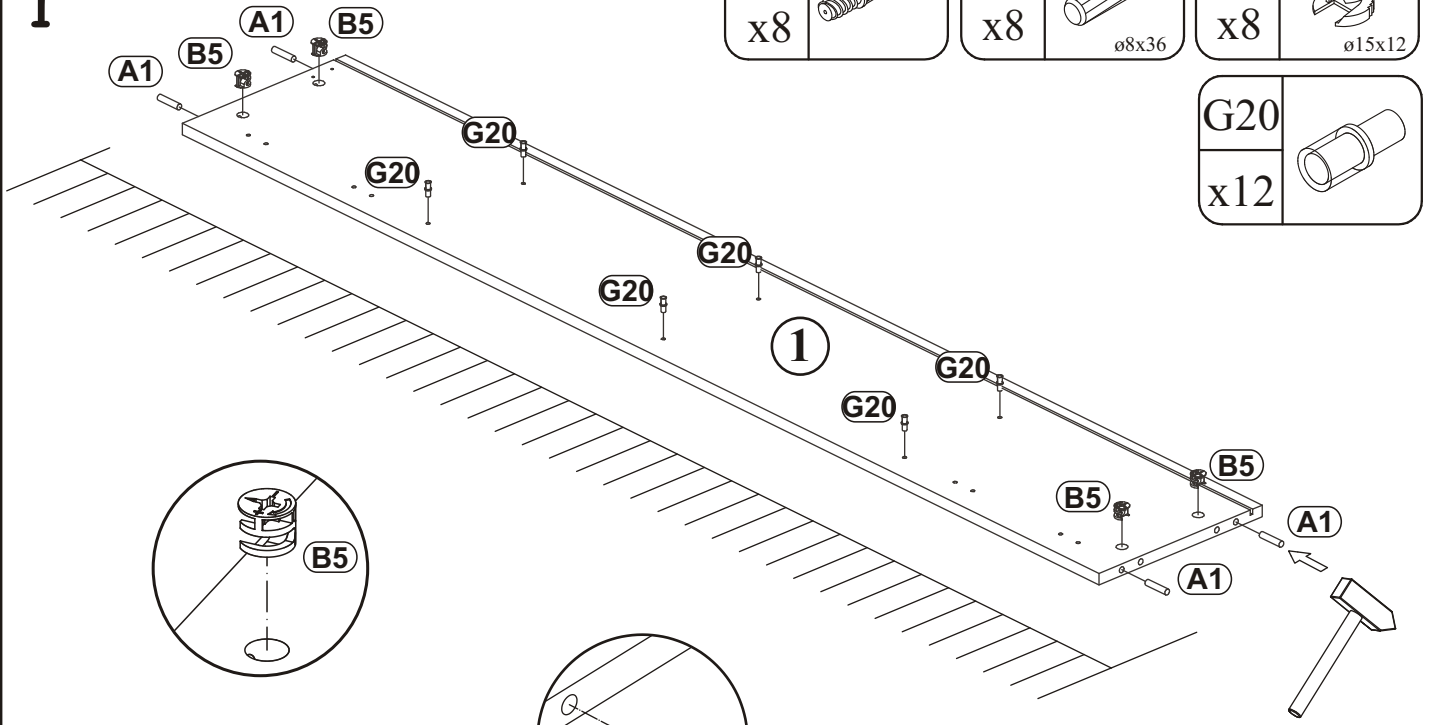

POINT TYP-41

2

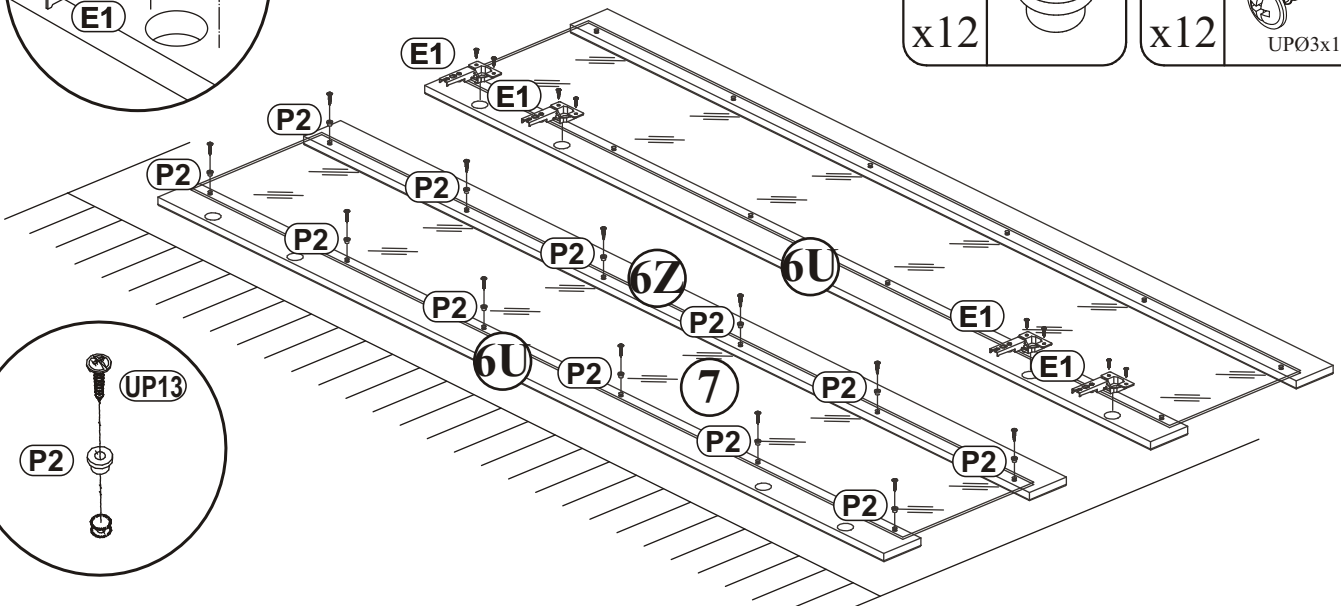
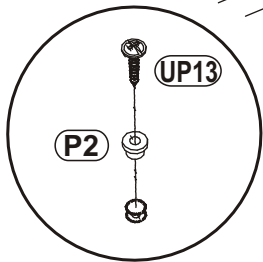
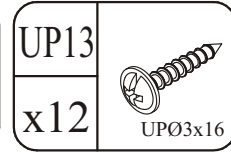
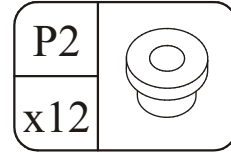
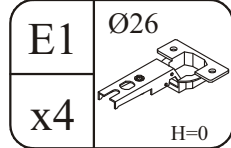
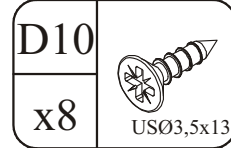
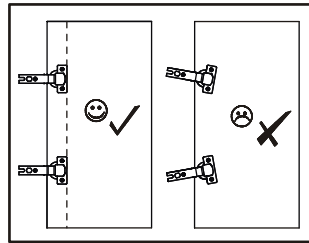
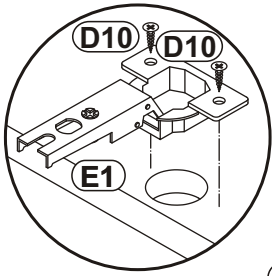

3

a)

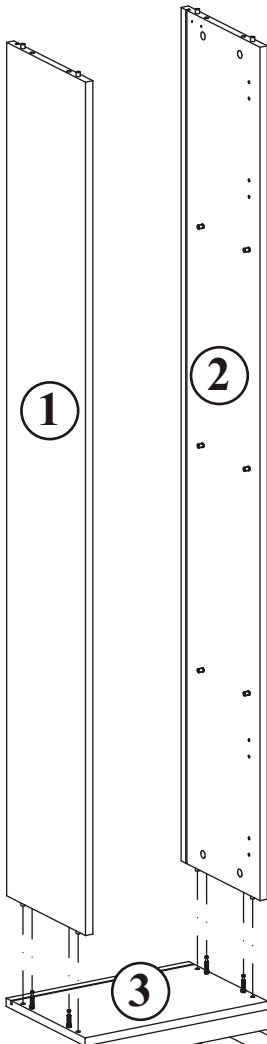

b)

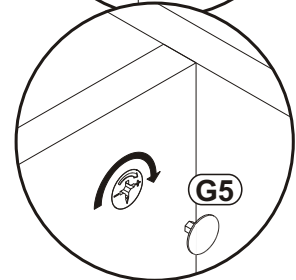
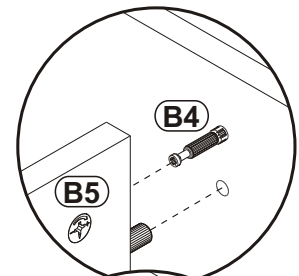
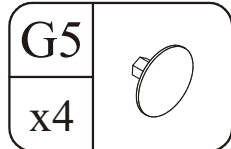
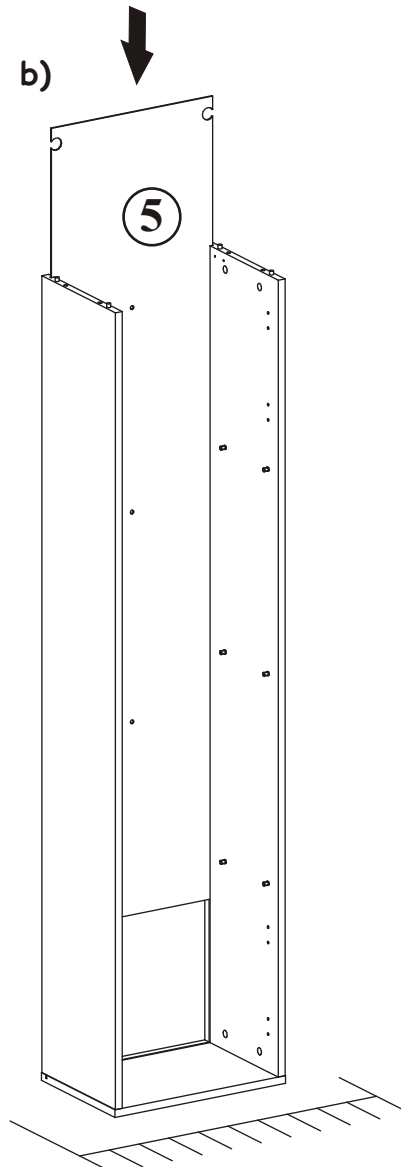

POINT TYP-41

4

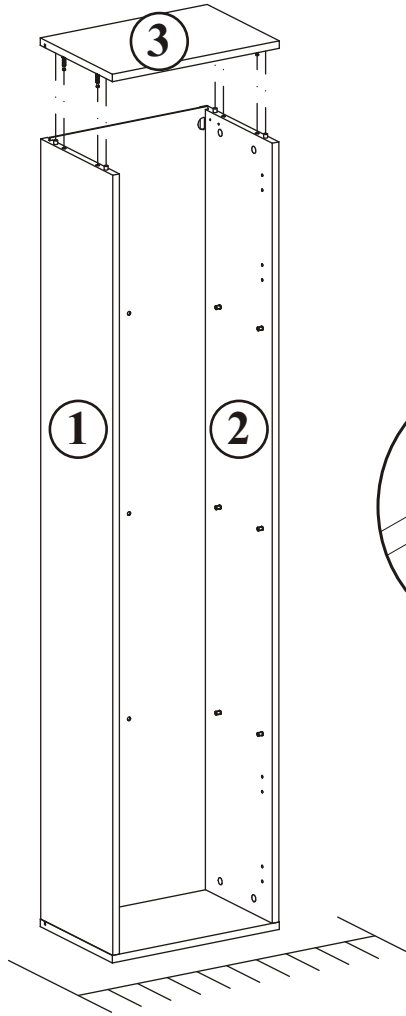

G5	
x4	

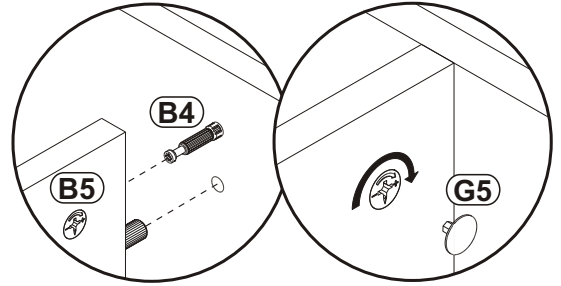

5



Y

X

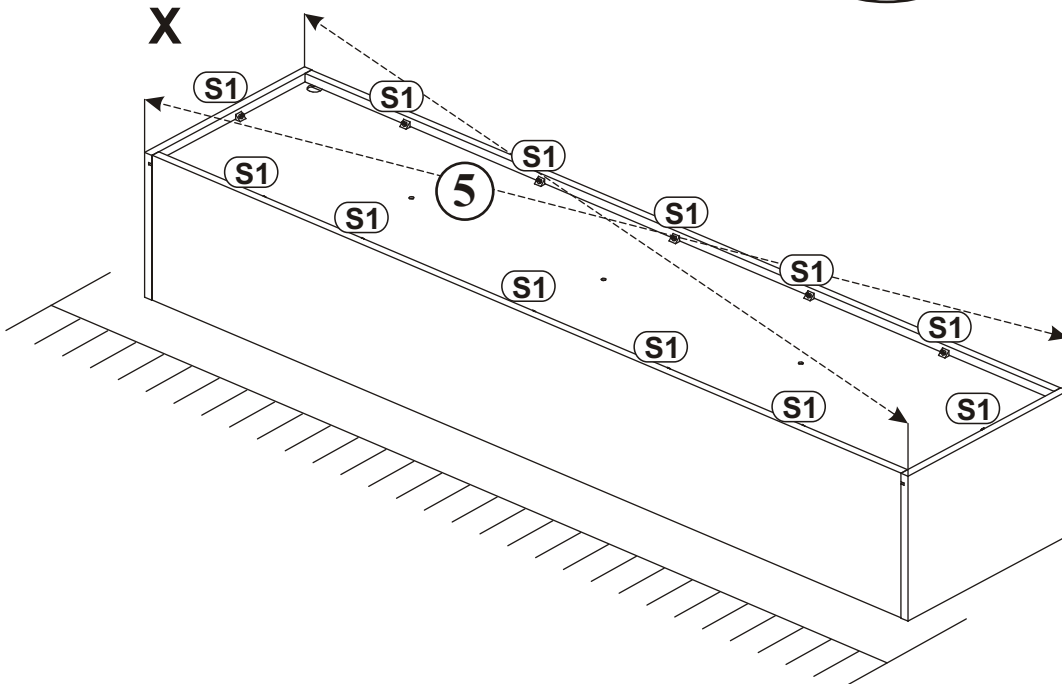

S1	
x12	

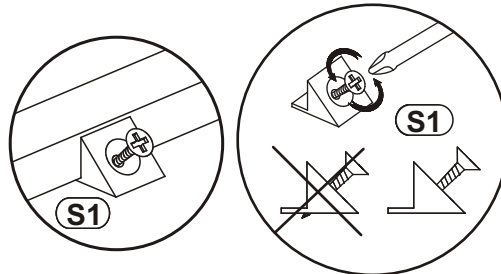

POINT TYP-41

6

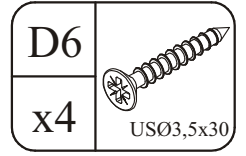
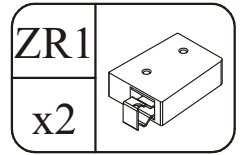
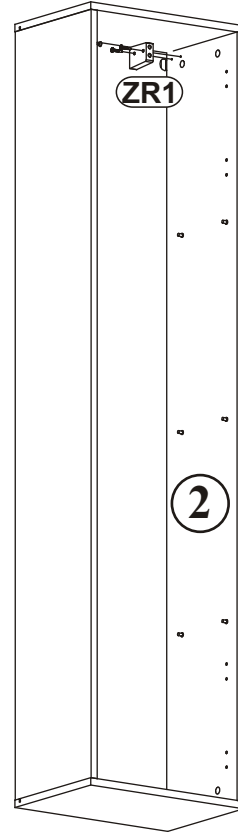
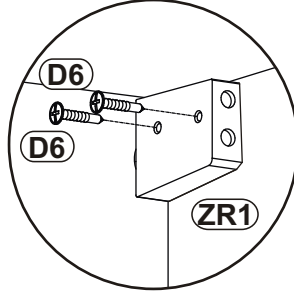
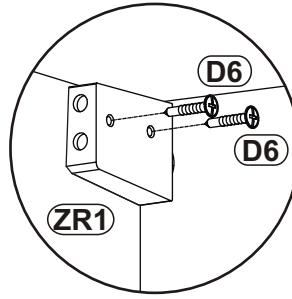
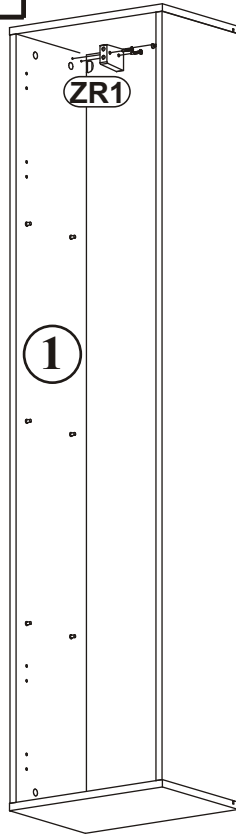

7

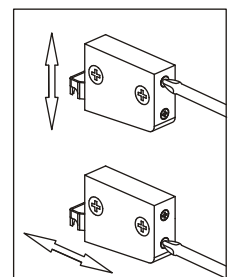
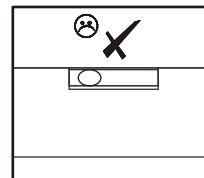
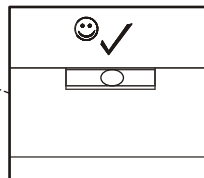
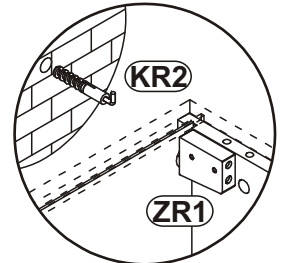
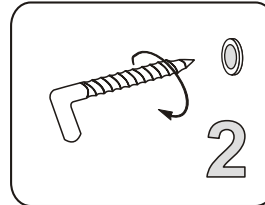
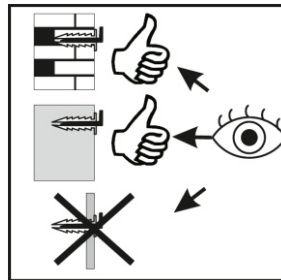
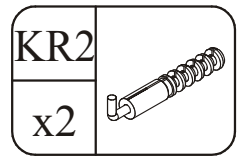
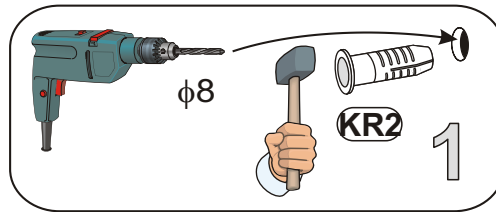
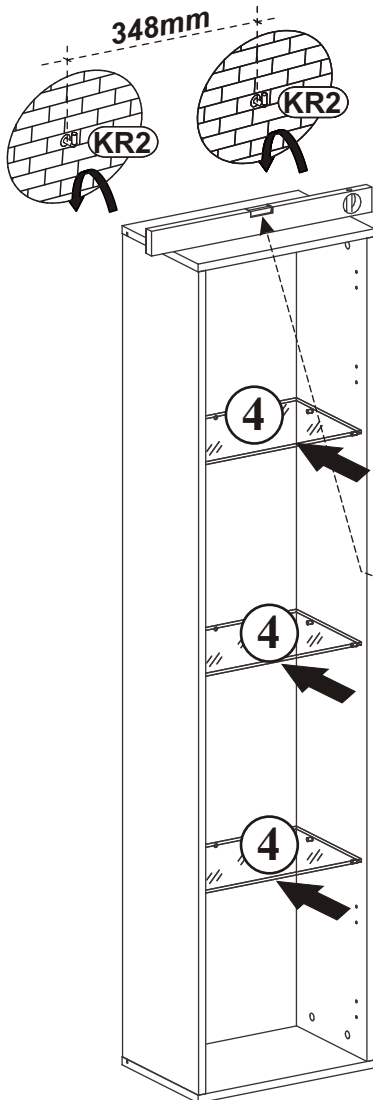

8 - 9

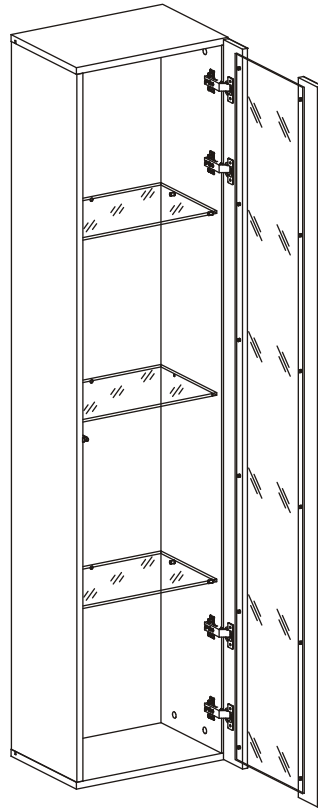

10 - 11

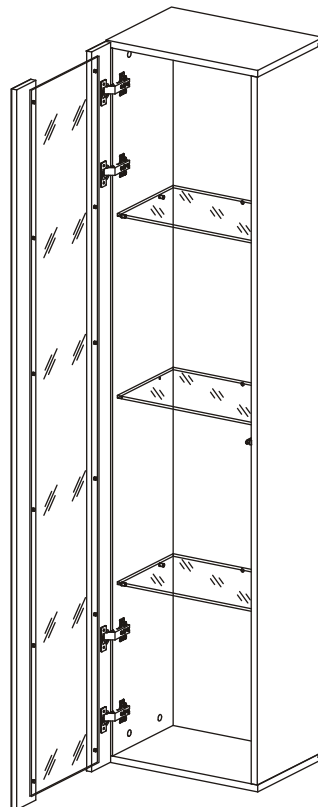

POINT TYP-41

8

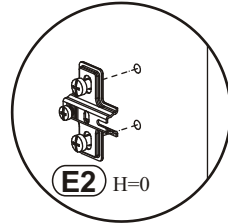
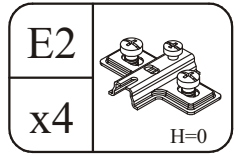
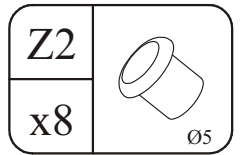
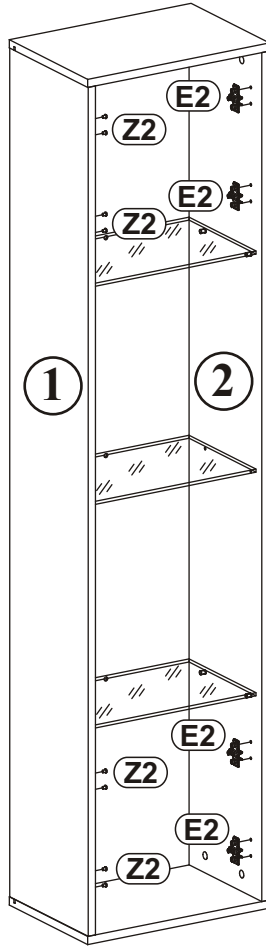
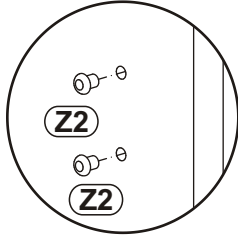
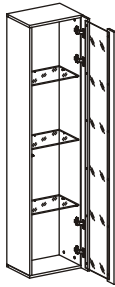

9

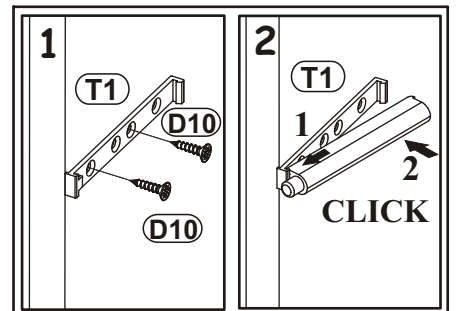
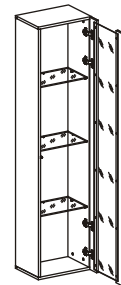
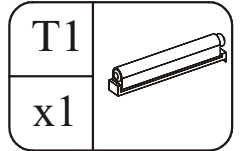
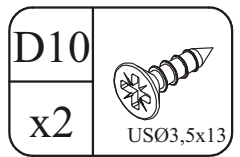
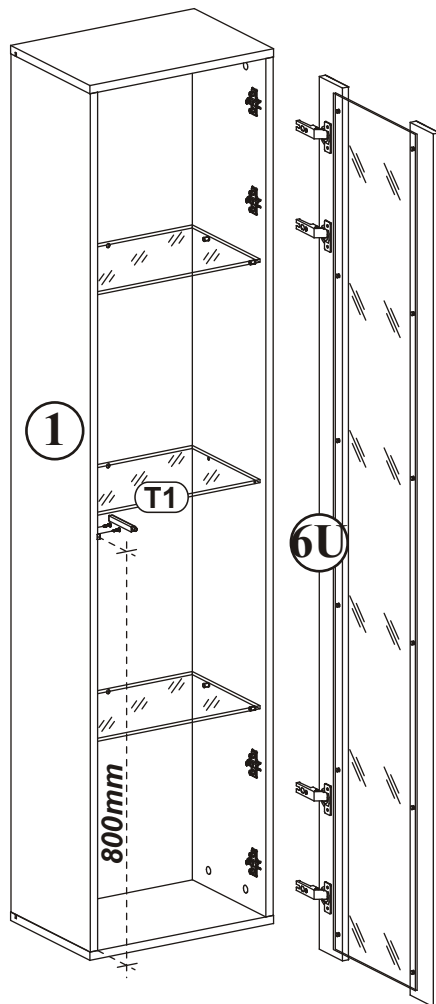
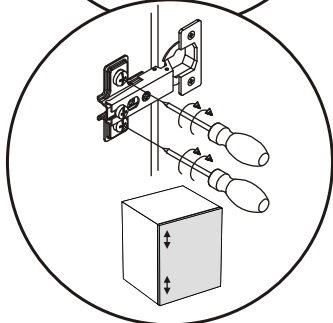
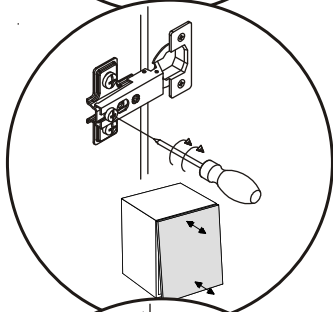
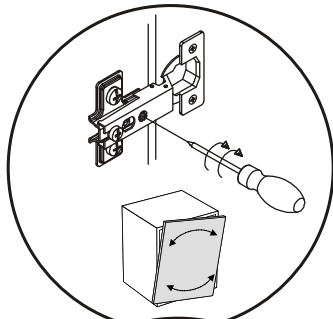



POINT TYP-41

10

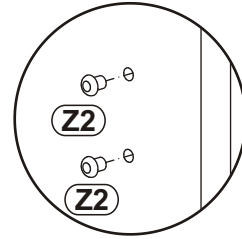
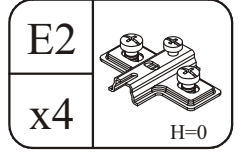
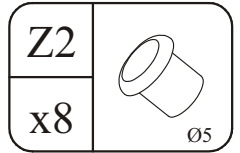
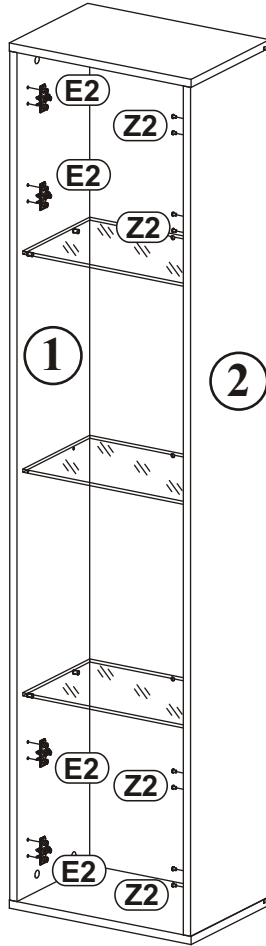
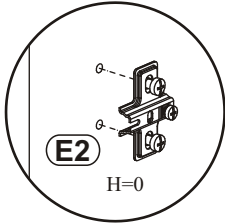
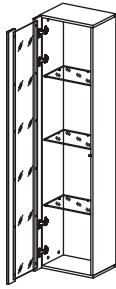

11

