

NO	Dim.		Col.-No	Qty
1	1370	750	1	1
2	594	180	1	1
3	594	180	1	1
4	150	179	3	1

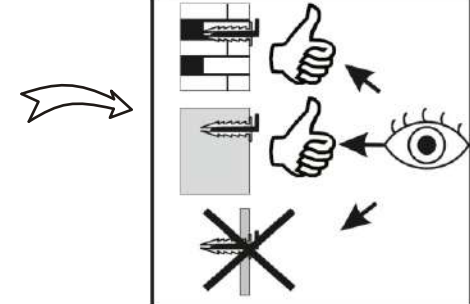

1

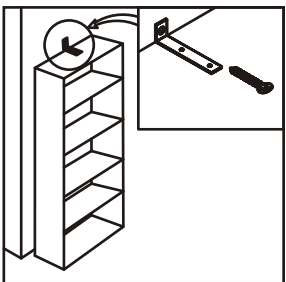
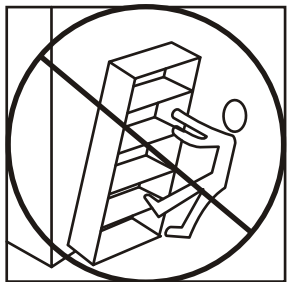
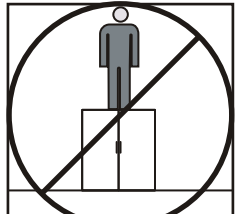
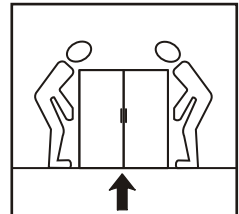
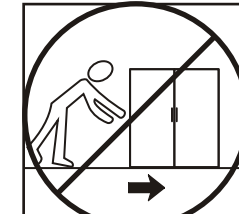
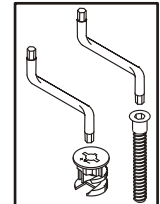
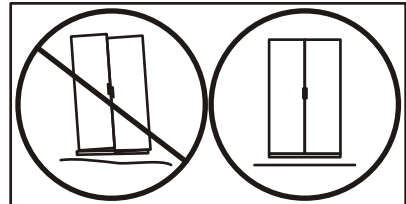
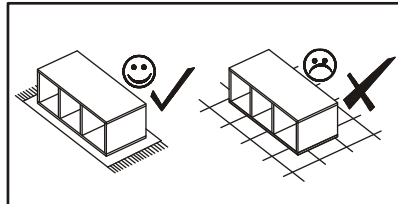
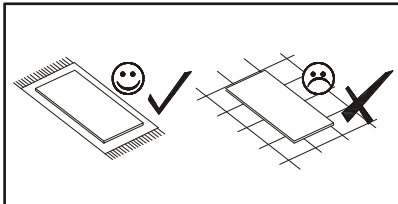
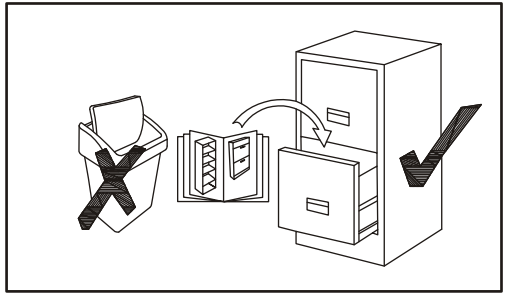
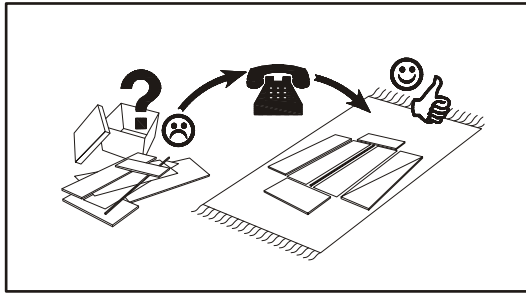
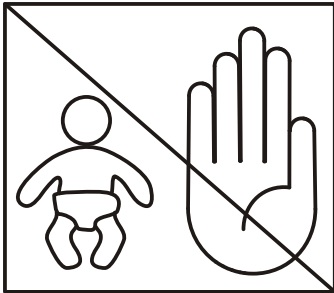
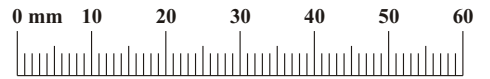
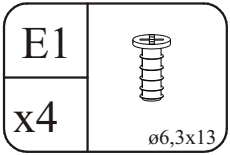
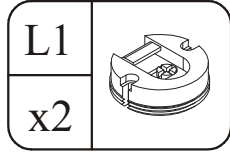
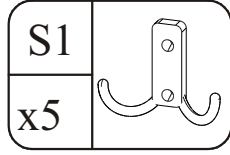
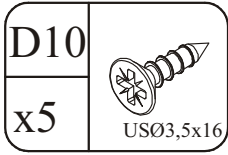
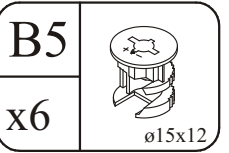
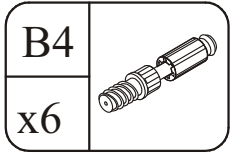
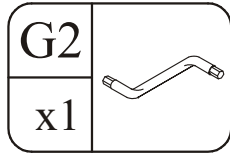
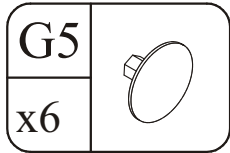
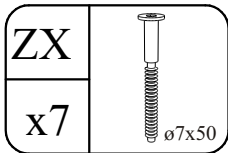
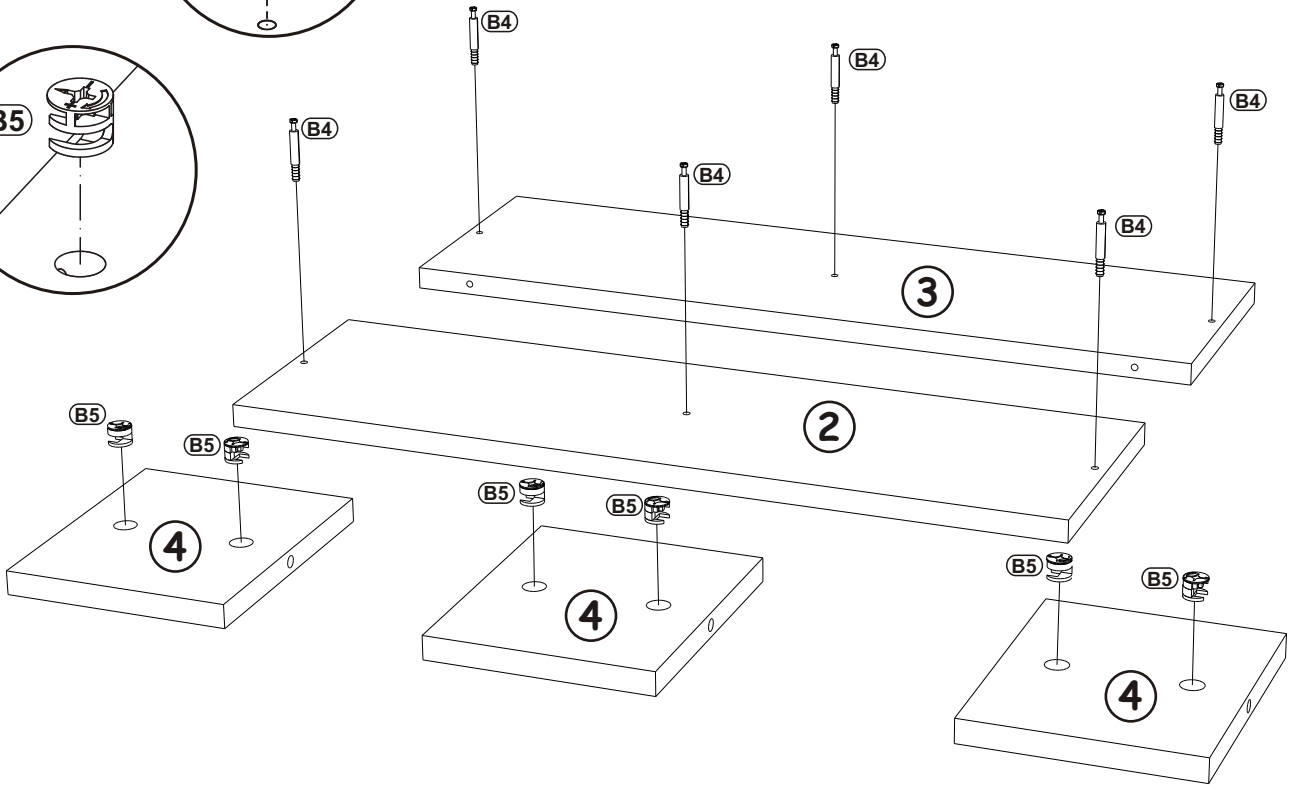
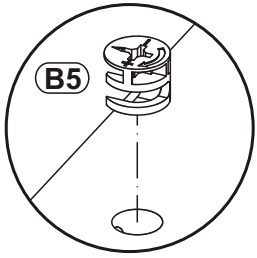
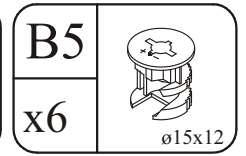
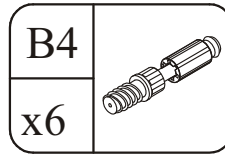
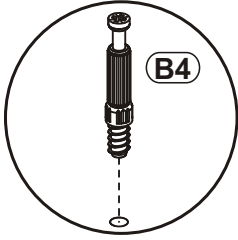

2

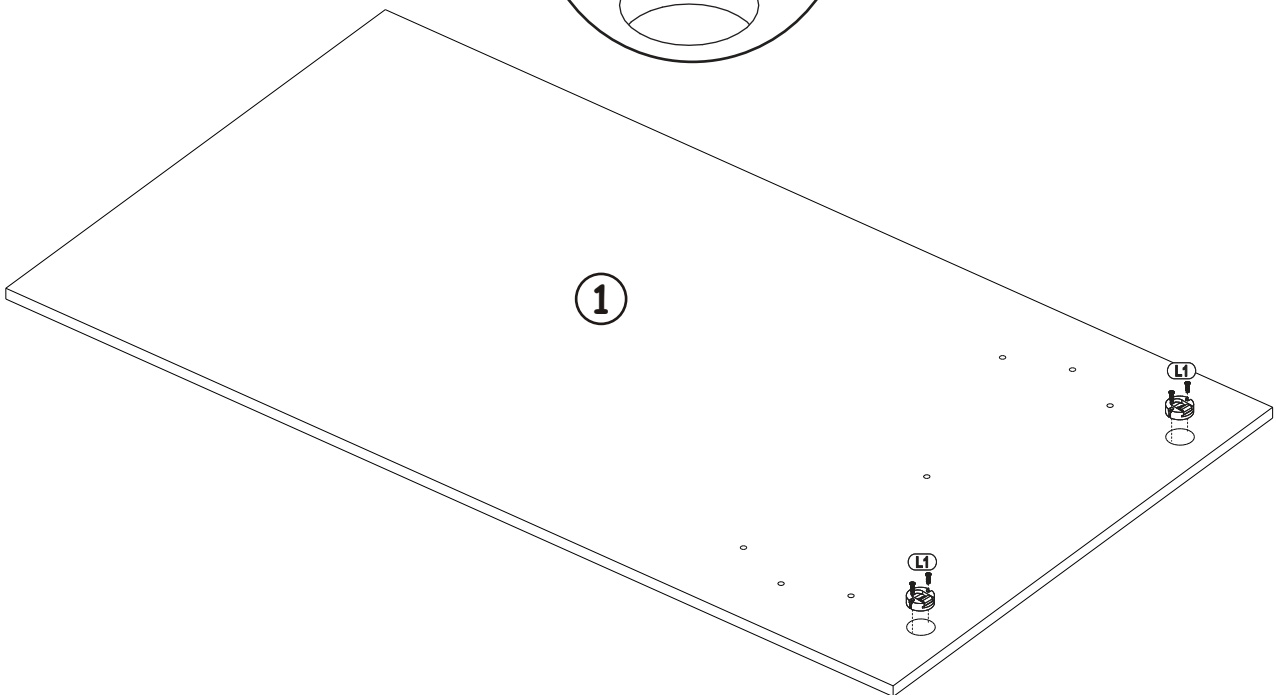
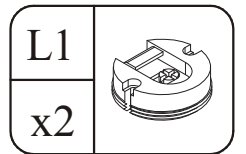
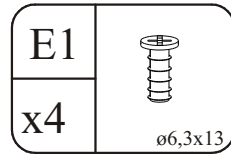
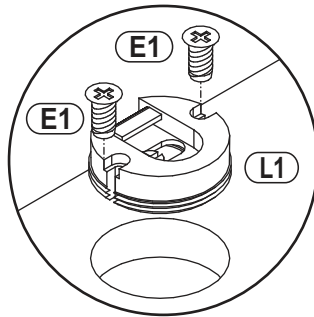
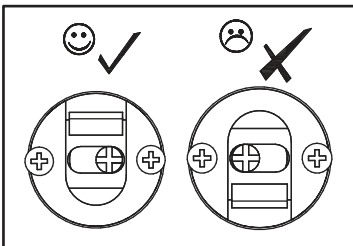

3

G5	
x6	

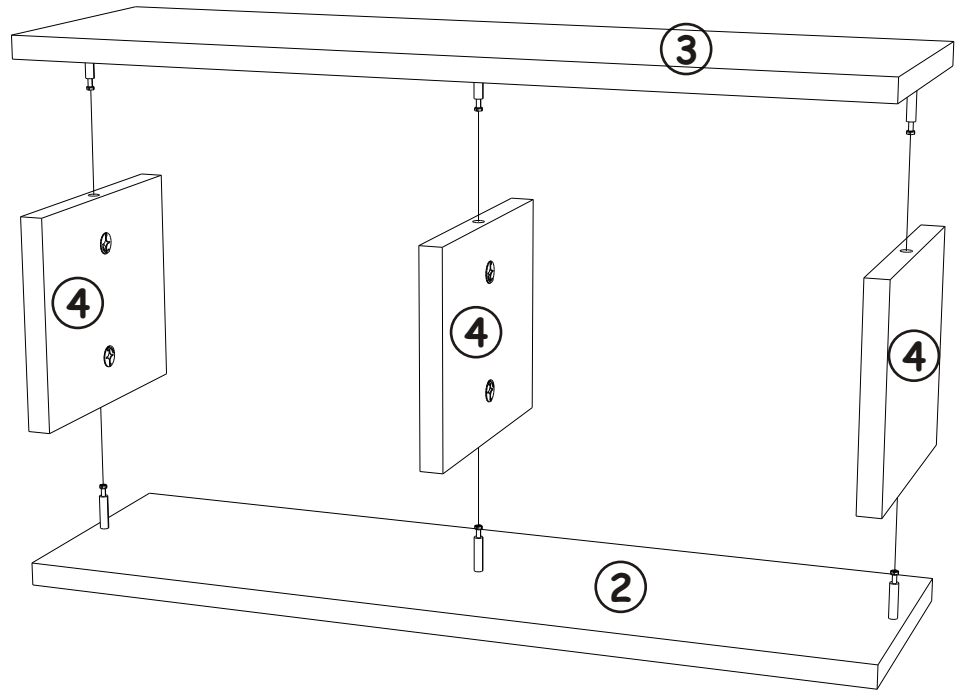
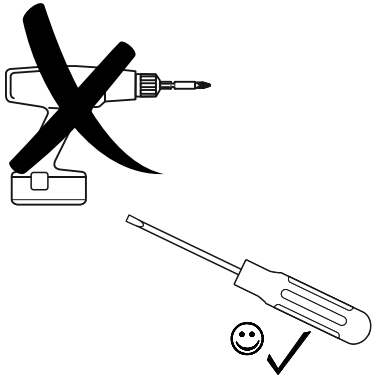
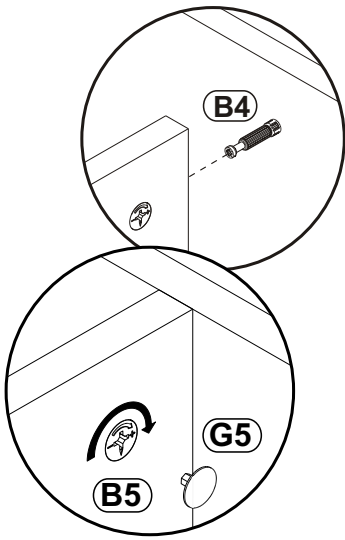

4

ZX	
x7	$\phi 7 \times 50$

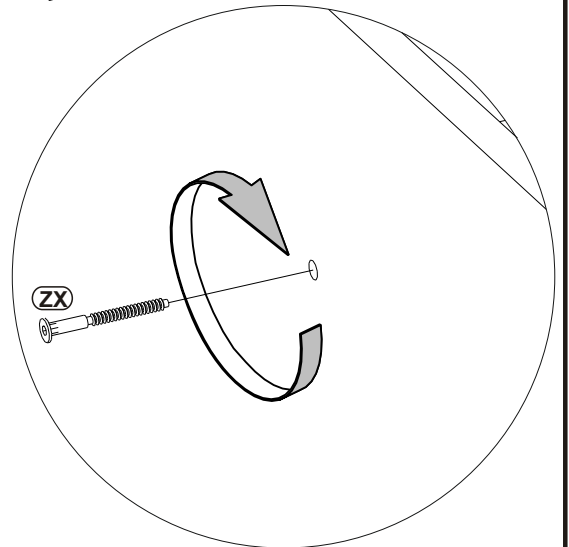
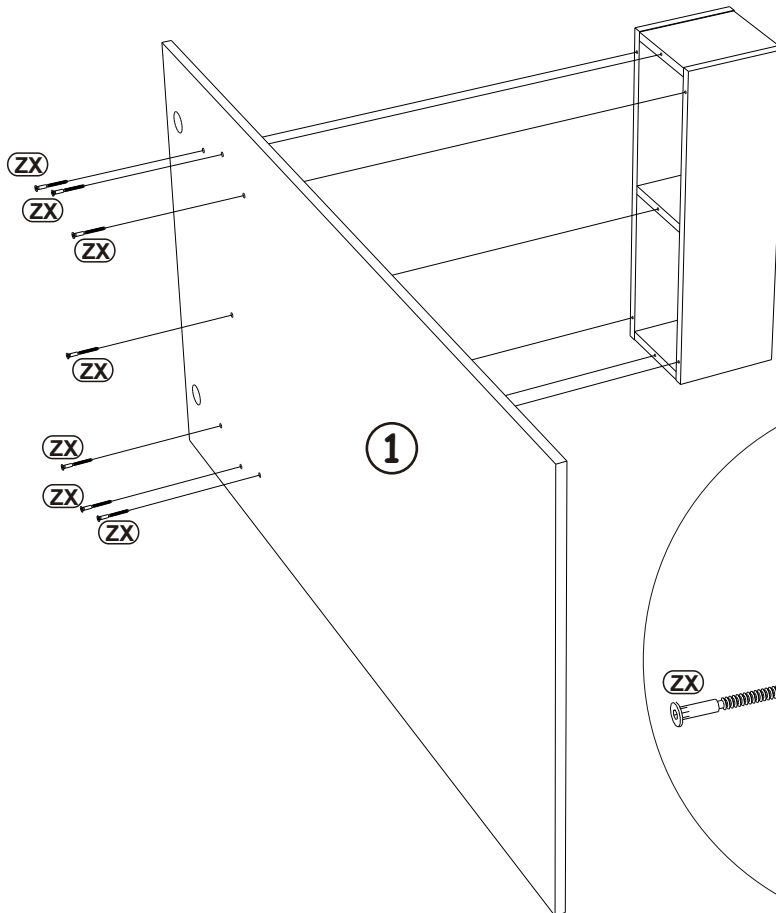

5

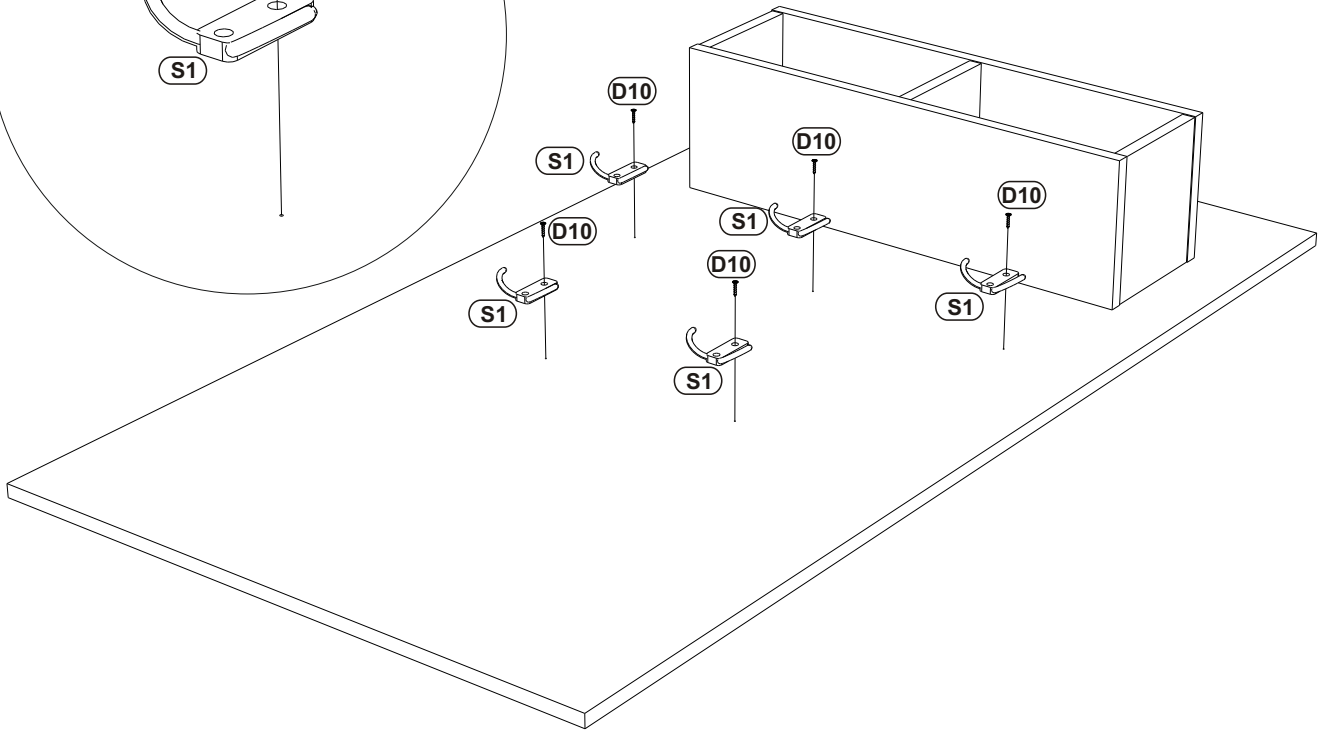
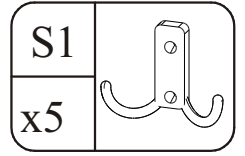
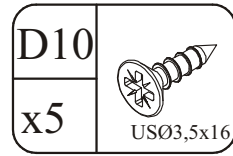
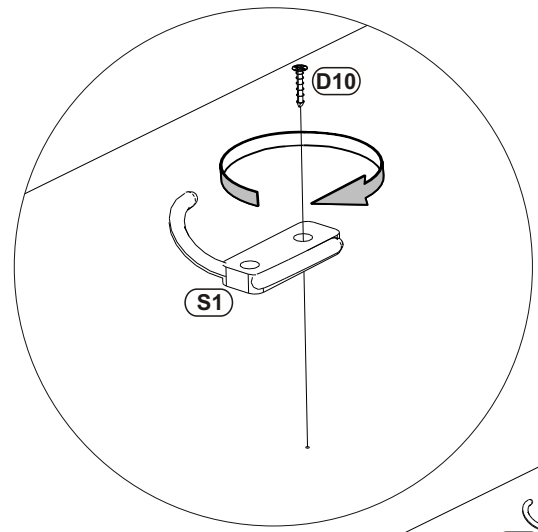

6

